

RODO

New Lighting Technology

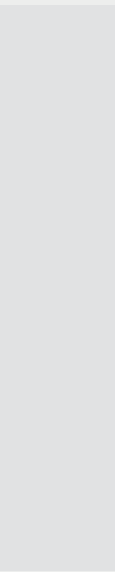

LED Downlight



RODO
New Lighting Technology

About RODO

Founded by a group of visionary lighting engineers, our company is at the forefront of crafting contemporary lighting solutions that harmonize with the evolution of architecture and construction.

Partnering with the world's leading lighting factories, we innovate with creative solutions, offering energy-efficient, long-lasting products.

Prioritizing quality, we provide a plethora of options for lighting designers, ensuring a robust warranty.

Committed to modern technology, our products seamlessly integrate with advancements like Smart Home, delivering lighting that is not only efficient but also visually soothing.

Our features



New lighting technologies



Innovative solutions



Energy saving



Long life



No Flicker



Quality of products



Options for lighting designers



Warranty up to 5 yr



Compatible with technology



Comfortable on eyes



HIGH CRI

PRODUCT STRUCTURE

SLR ADV SERIES



Recessed Downlight

5 Size
7-50W



SLR ADV Full Size Downlight Family

LED DOWNLIGHT

RO-RDXX-133-EA101X



Sand White

15°

24°

36°

55°

Recessed 55
Trimless round

Size: $\varnothing 62 \times H75$ mm





Luminaire Power	LED Power	CRI	Flux	CCT	Beam	Driver Current
7W	5.8W	90	469lm	3000K	15°/24°/36°/55°	DC180mA

24°

7W±10%/3000K / Ra90

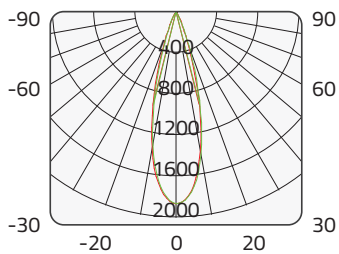

	(lx)	(cm)
1m	1870	50.15
2m	467.4	100.30
3m	207.7	150.45
4m	116.9	200.60
5m	74.79	250.75

RO-RDXX-133-EA102X



Sand White

15°

24°

36°

55°

Recessed 55
Trimless round

Size: $\varnothing 70 \times H75$ mm

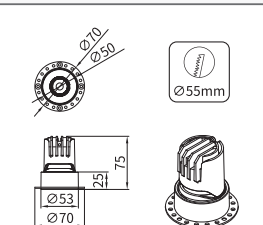



Luminaire Power	LED Power	CRI	Flux	CCT	Beam	Driver Current
7W	5.8W	90	469lm	3000K	15°/24°/36°/55°	DC180mA

24°

7W±10%/3000K / Ra90

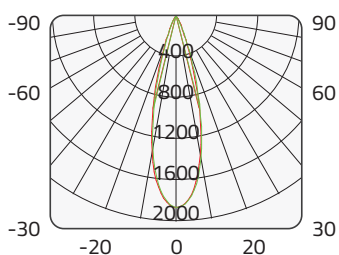

	(lx)	(cm)
1m	1870	50.15
2m	467.4	100.30
3m	207.7	150.45
4m	116.9	200.60
5m	74.79	250.75

RO-RDXX-130-EA117X



Sand White

 15°
  24°
  36°
  55°

Recessed 75
Trimless round

Size: Ø83xH92mm









Luminaire Power	LED Power	CRI	Flux	CCT	Beam	Driver Current
12W	10.2W	90	787lm	3000K	15°/24°/36°/55°	DC250mA

24°

12W±10%/3000K / Ra90

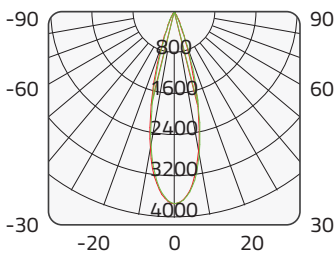





	(lx)	(cm)
1m	3825	41.91
2m	956.1	83.80
3m	425.0	125.69
4m	239.0	167.59
5m	153.0	209.49

RO-RDXX-130-EA118X







Sand White

 15°
  24°
  36°
  55°

Recessed 75
Trimless round

Size: Ø95xH92mm

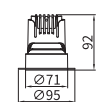





Luminaire Power	LED Power	CRI	Flux	CCT	Beam	Driver Current
12W	10.2W	90	787lm	3000K	15°/24°/36°/55°	DC250mA

24°

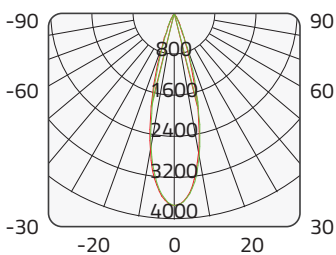
12W±10%/3000K / Ra90



	(lx)	(cm)
1m	3825	41.91
2m	956.1	83.80
3m	425.0	125.69
4m	239.0	167.59
5m	153.0	209.49

LED DOWNLIGHT

RO-RDXX-134-EA105X



○ Sand White

 15°



 24°



 36°

 55°

Recessed 95
Trim round

Size: $\varnothing 105 \times H115$ mm

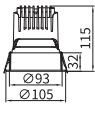





Luminaire Power	LED Power	CRI	Flux	CCT	Beam	Driver Current
20W	17W	90	1817lm	3000K	15°/24°/36°/55°	DC500mA

24°

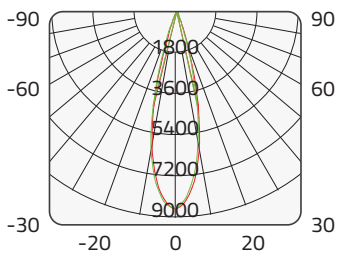
20W±10%/3000K / Ra90



Distance	(lx)	(cm)
1m	8516	46.97
2m	2129	93.95
3m	946.2	104.92
4m	532.2	187.89
5m	340.6	234.87

RO-RDXX-134-EA106X



○ Sand White

 15°

 24°

 36°

 55°

Recessed 95
Trimless round

Size: $\varnothing 120 \times H115$ mm



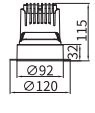





Luminaire Power	LED Power	CRI	Flux	CCT	Beam	Driver Current
20W	17W	90	1817lm	3000K	15°/24°/36°/55°	DC500mA

24°

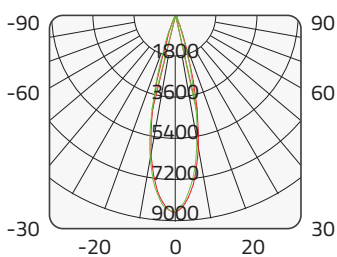
20W±10%/3000K / Ra90





Distance	(lx)	(cm)
1m	8516	46.97
2m	2129	93.95
3m	946.2	104.92
4m	532.2	187.89
5m	340.6	234.87

RO-RDXX-135-EA109X



Sand White

 15°

 24°

 36°

 55°

Recessed 120
Trim round

Size: Ø140xH149mm

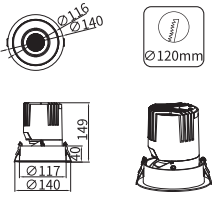



Luminaire Power	LED Power	CRI	Flux	CCT	Beam	Driver Current
30W	25.8W	90	2514lm	3000K	15°/24°/36°/55°	DC750mA

24°

30W±10%/3000K / Ra90

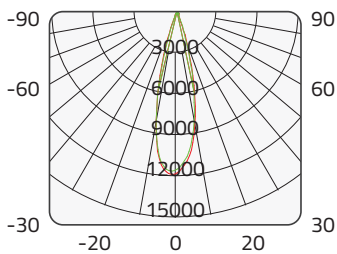



	(lx)	(cm)
1m	11735	45.6
2m	2934	91.19
3m	1304	136.79
4m	733.4	182.38
5m	469.4	227.98

RO-RDXX-135-EA110X



Sand White

 15°

 24°

 36°

 55°

Recessed 120
Trimless round

Size: L213xW119xH149mm

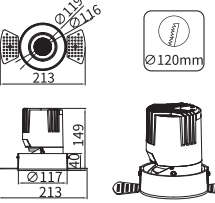



Luminaire Power	LED Power	CRI	Flux	CCT	Beam	Driver Current
30W	25.8W	90	2514lm	3000K	15°/24°/36°/55°	DC750mA

24°

30W±10%/3000K / Ra90

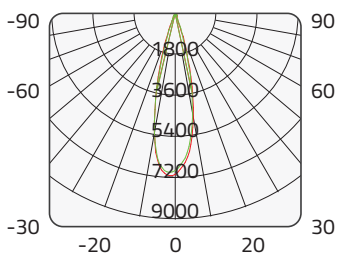

	(lx)	(cm)
1m	11735	45.6
2m	2934	91.19
3m	1304	136.79
4m	733.4	182.37
5m	469.4	227.98

LED DOWNLIGHT

RO-RDXX-136-EA113X



Sand White

15°



24°



36°

55°

Recessed 145
Trim round

Size: $\varnothing 168 \times H179$ mm







Luminaire Power	LED Power	CRI	Flux	CCT	Beam	Driver Current
50W	43W	90	4040lm	3000K	15°/24°/36°/55°	DC1250mA

24°

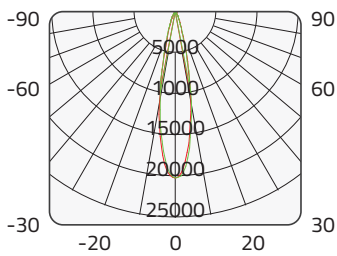
50W±10%/3000K / Ra90



	(lx)	(cm)
1m	20219	37.96
2m	5055	75.90
3m	2247	113.85
4m	1264	151.79
5m	808.8	189.74

RO-RDXX-136-EA114X



Sand White

15°



24°



36°

55°

Recessed 145
Trimless round

Size: L237×W168×H179mm







Luminaire Power	LED Power	CRI	Flux	CCT	Beam	Driver Current
50W	43W	90	4040lm	3000K	15°/24°/36°/55°	DC1250mA

24°

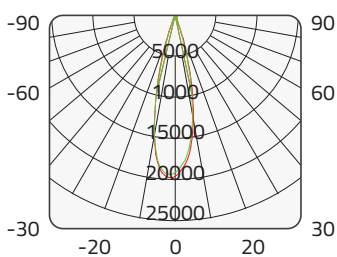
50W±10%/3000K / Ra90



	(lx)	(cm)
1m	20219	37.96
2m	5055	75.90
3m	2247	113.85
4m	1264	151.79
5m	808.8	189.74

RO-CLXX-116



○ Sand White

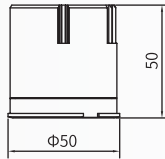
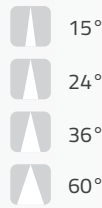

RO-CLXX-116

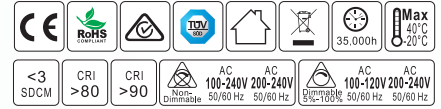

Part No	Luminaire Power	LED Power	CRI	Flux	CCT	Beam	Driver Current
RO-CL08-116	8W	6.8W	80	927lm	3000K	15°/24°/36°/60°	DC200mA
RO-CL11-116	11W	8.5W	80	1182lm	3000K	15°/24°/36°/60°	DC250mA
RO-CL08-116	8W	6.8W	90	772lm	3000K	15°/24°/36°/60°	DC200mA
RO-CL11-116	11W	8.5W	90	971lm	3000K	15°/24°/36°/60°	DC250mA

RO-CL08-116

Luminus 8W±10% 3000K 15° Ra80

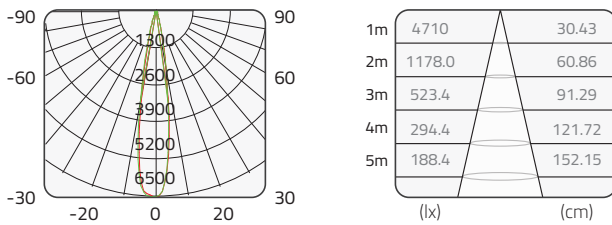

Luminus 8W±10% 3000K 24° Ra80

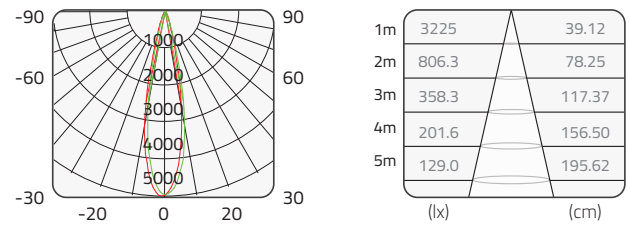

Luminus 8W±10% 3000K 36° Ra80

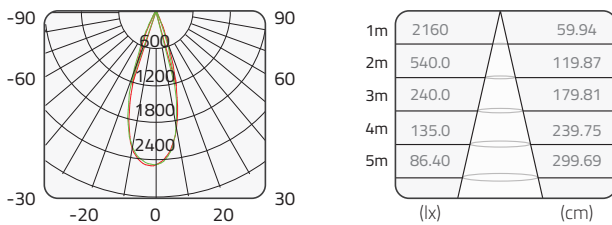

Luminus 8W±10% 3000K 60° Ra80

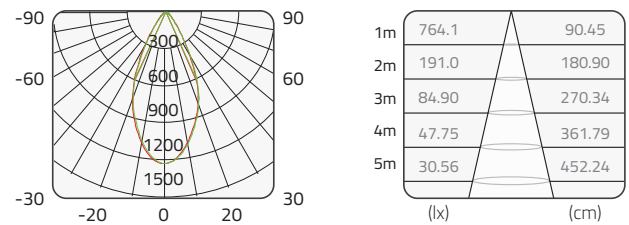

Luminus 8W±10% 3000K 15° Ra90

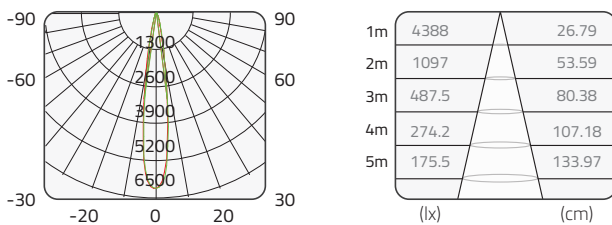

Luminus 8W±10% 3000K 24° Ra90

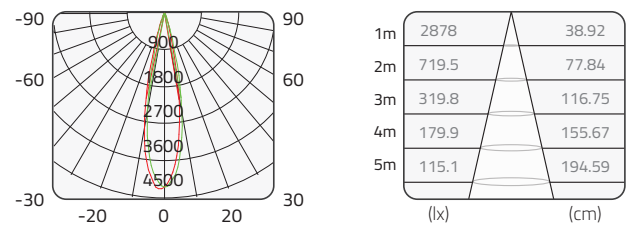

Luminus 8W±10% 3000K 36° Ra90

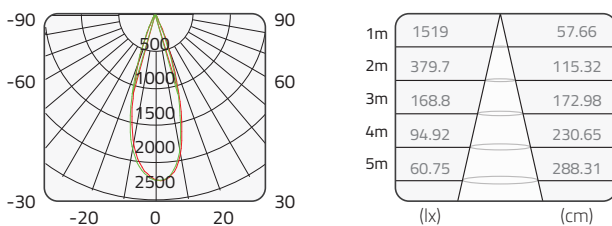

Luminus 8W±10% 3000K 60° Ra90

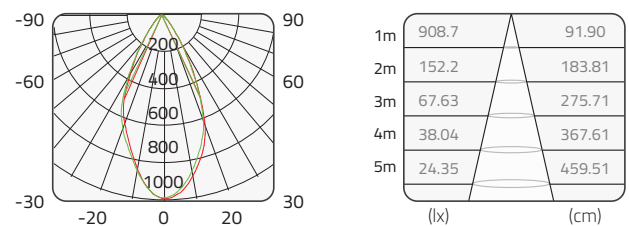

LED DOWNLIGHT

RO-CL11-116

Luminus 11W±10% 3000K 15° Ra80

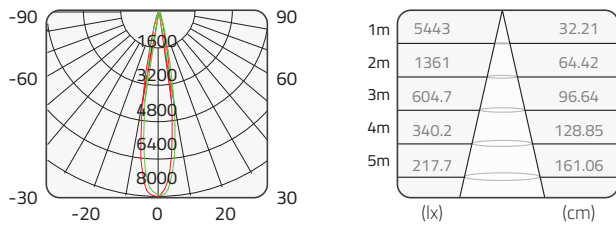

Luminus 11W±10% 3000K 24° Ra80

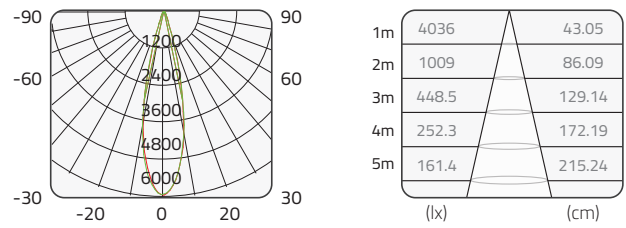

Luminus 11W±10% 3000K 36° Ra80

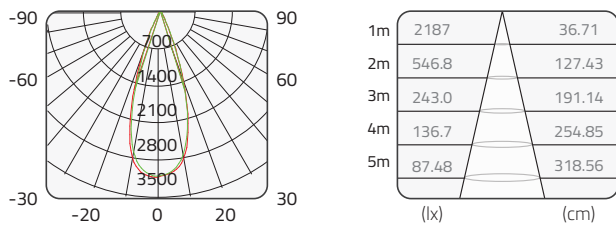

Luminus 11W±10% 3000K 60° Ra80

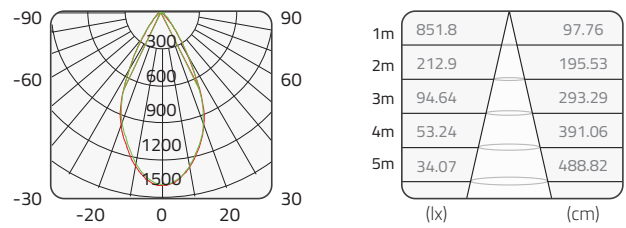

Luminus 11W±10% 3000K 15° Ra90

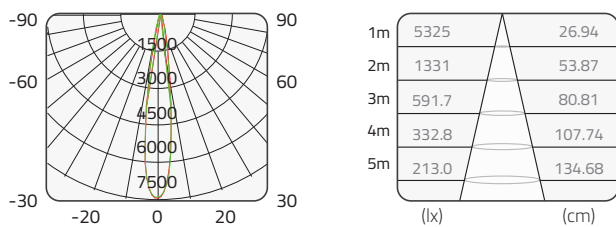

Luminus 11W±10% 3000K 24° Ra90

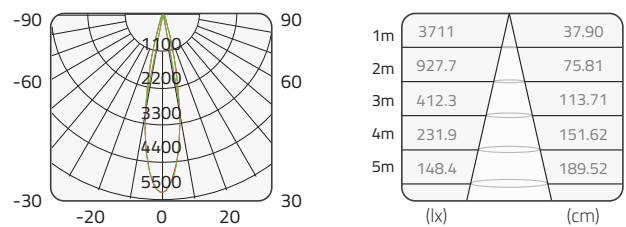

Luminus 11W±10% 3000K 36° Ra90

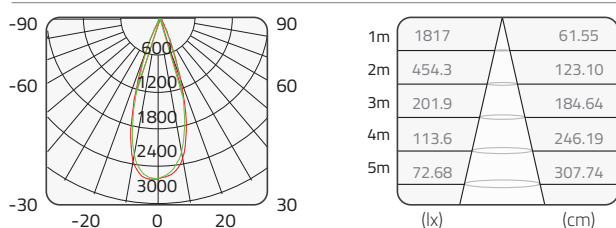

Luminus 11W±10% 3000K 60° Ra90

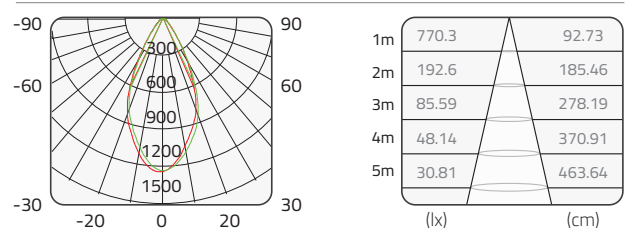

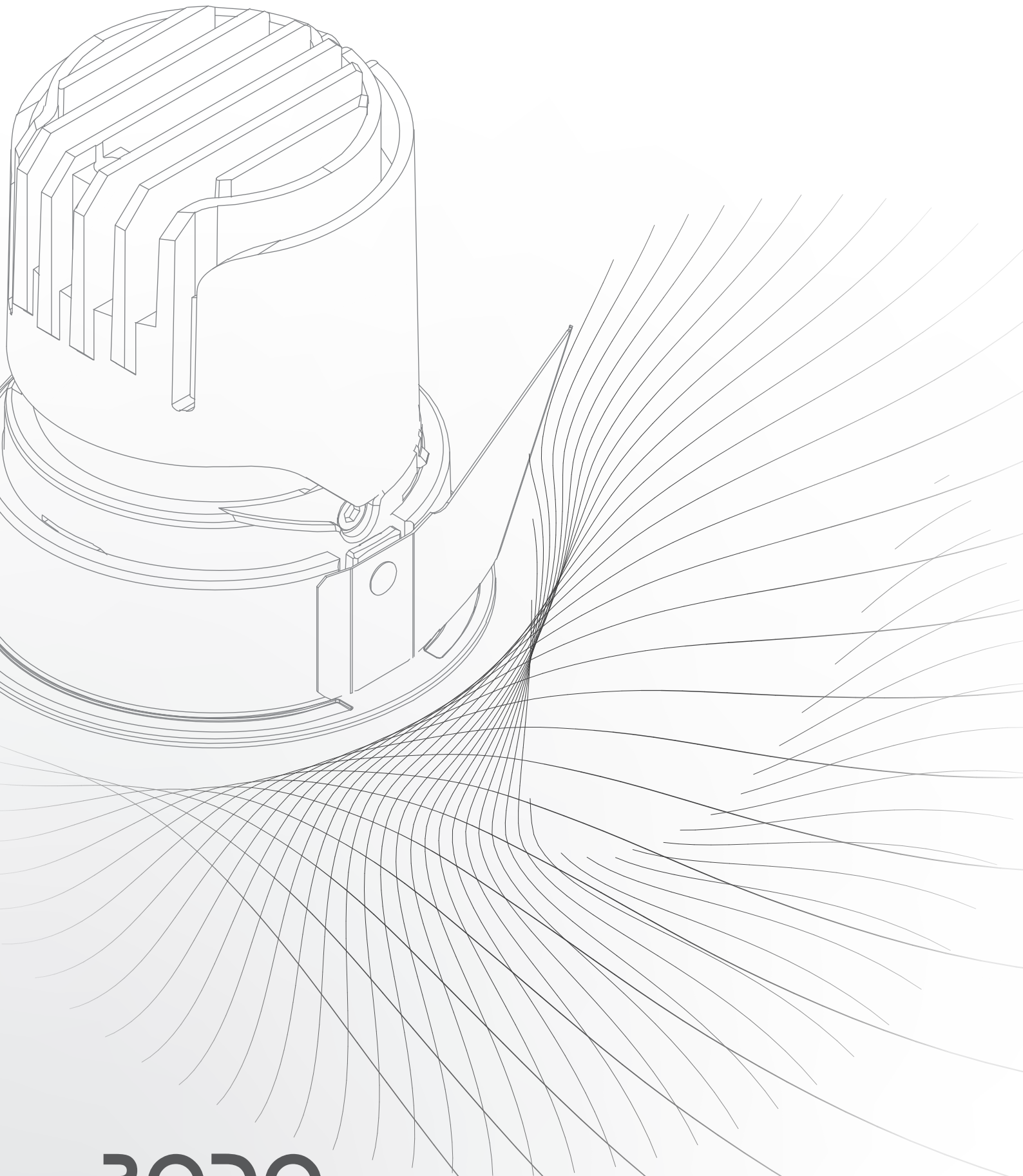

RODO

www.rodolights.com

📍 Oman, Muscat

📞 +968 906 00 810

✉ info@rodolights.com

